

[1] * 1

[2] * 1

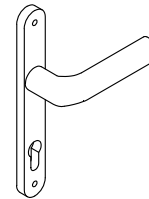
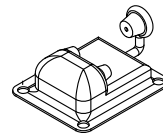
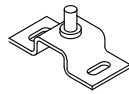
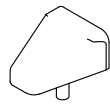

[3] * 2

[4] * 2

[5] * 1

[6] * 2

[7] * 1



[8] * 1

[9] * 1

[10] * 3

[11] * 1

[12] * 1

[13] * 1

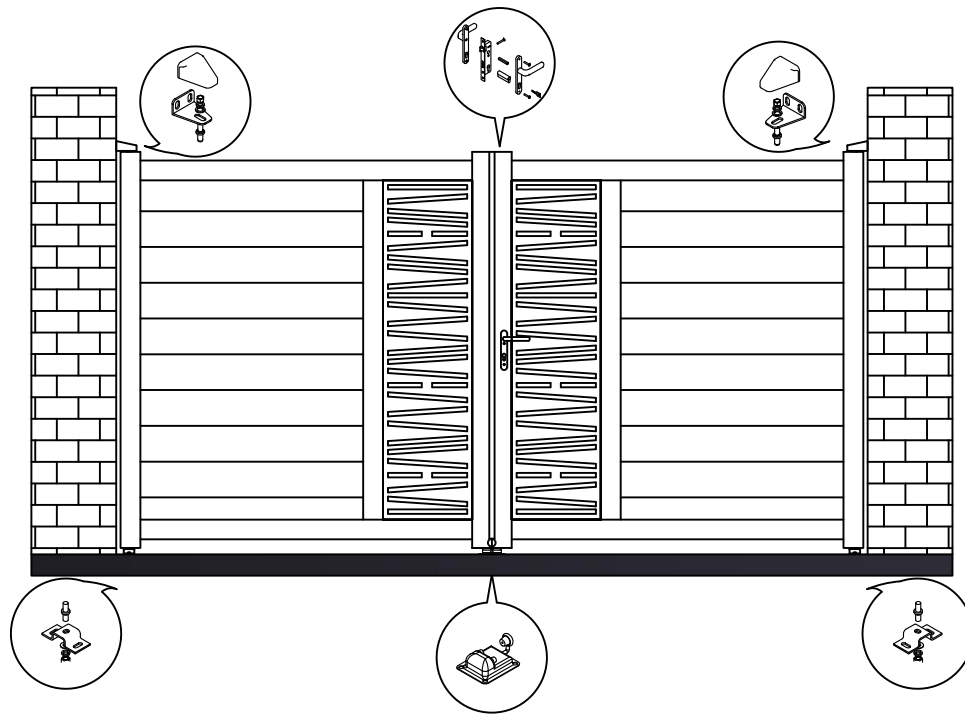

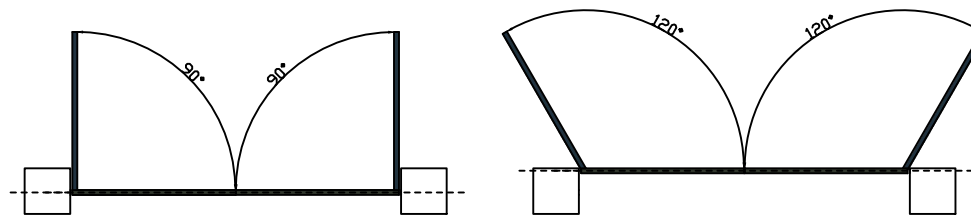
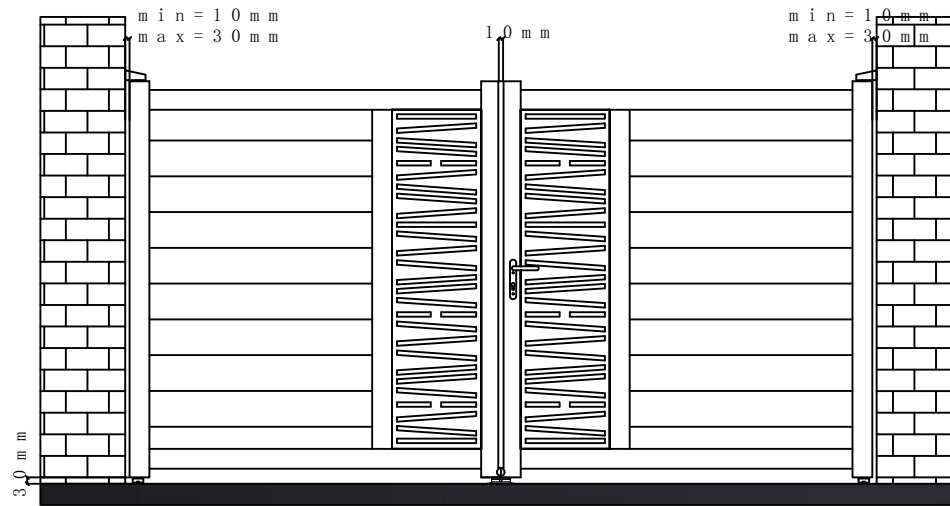

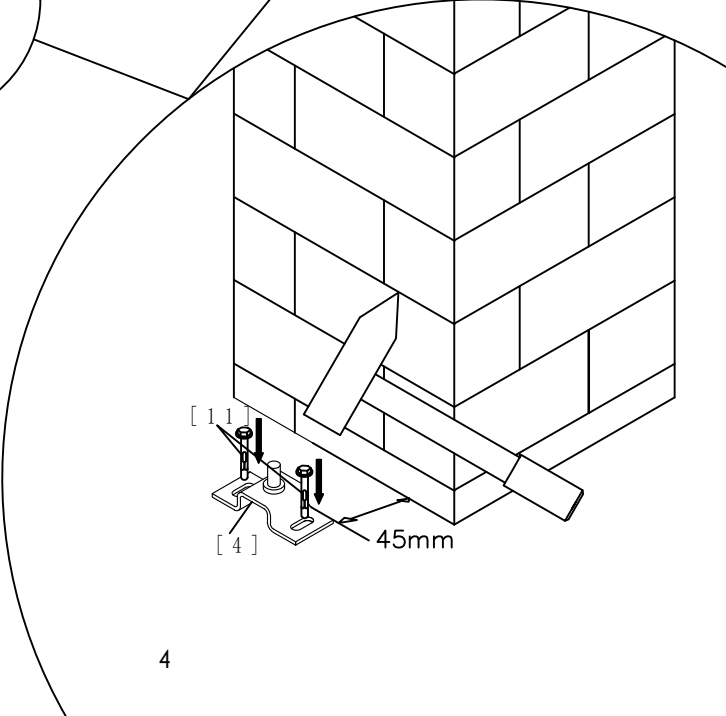
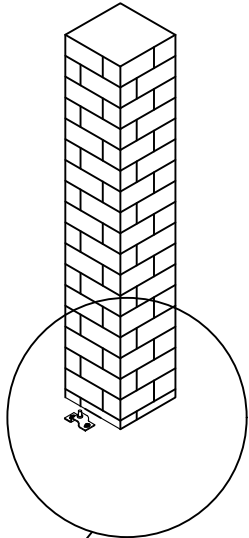
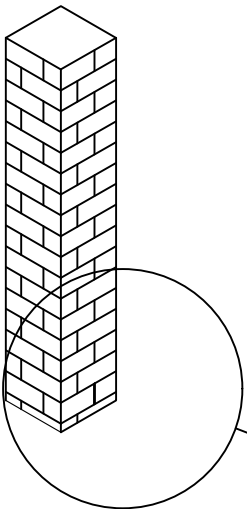
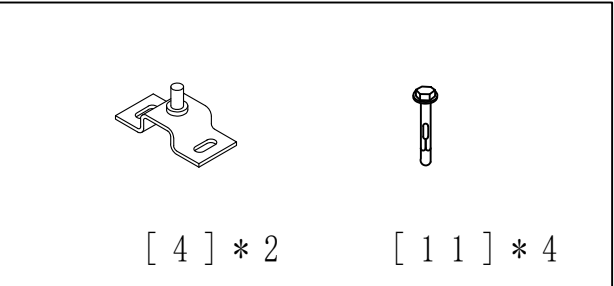

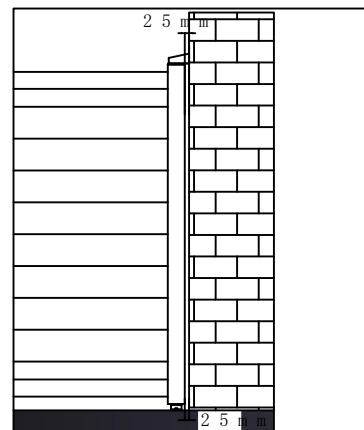
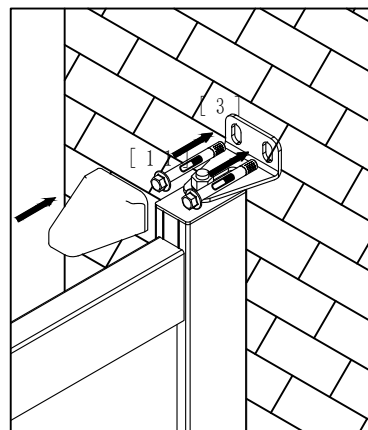
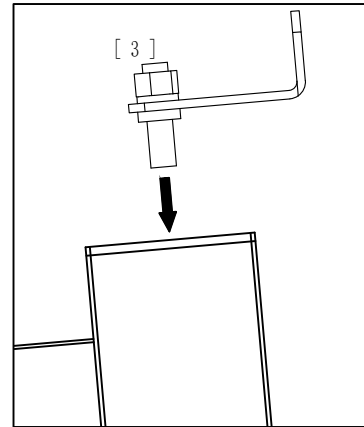
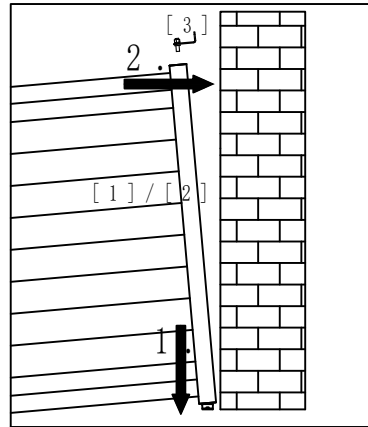
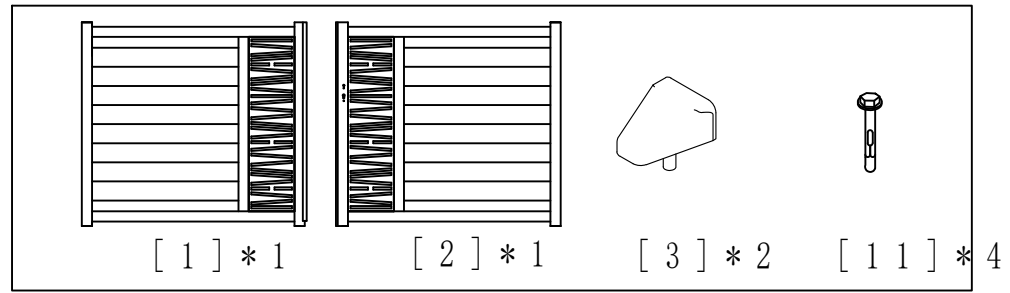

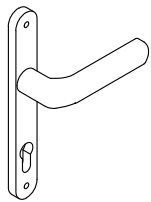

[6] * 2



[7] * 1



[8] * 1



[9] * 1



[1 0] * 3



[1 2] * 2



[1 3] * 1

